

XL8004 DEMO Board manual

Introduction

The document describes a high efficiency LED driver designed to drive an LED driver at a current of 300&600 mA from an input voltage range of 24 VDC to80 VDC, output support 3~8 series 1/3W LED.

The XL8004 also provides a sophisticated range of protection features including auto-restart for control loop open/short faults and output short-circuit conditions. Accurate hysteretic thermal shutdown ensures safe average PCB temperatures under all conditions. Design with very low parts count.

This document contains the converter specification, schematic, PCB diagram, bill of materials.

Schematic

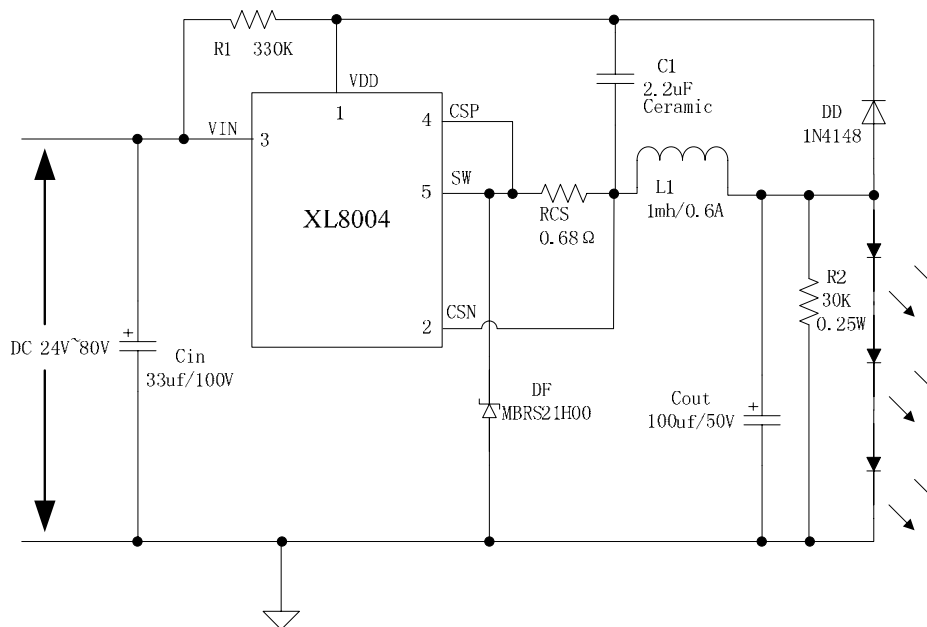

XL8004 Typical Application Circuit (3W~8W LED lamp)

Pin Description

Pin Number	Pin Name	Description
1	VDD	The chip supply voltage.
2	CSN	Current Sense Negative Terminal.
3	VIN	Input high voltage Pin. (Operation voltage 24V~ 80V).
4	CSP	Current Sense Positive Terminal.
5	SW	Output Switching Pin.

Bill of Materials

Item	Qty	Ref Des	Description	Mfg Part Number	Mfg
1	1	C1	2.2uF,50V,Ceramic,X7R,0805	C2012X7R1H225K	TDK
2	1	Cin	33uF,100V,Electrolytic,(8x11.5)	YXA-100V-33uF	Rubycon
3	1	Cout	100uF,50V,Electrolytic,(8x11.5)	YXA-50V-100uF	Rubycon
4	1	D1	100V,2A,Schottky Rectifier,SMB	MBRS2H100T3G	Onsemi
5	1	DD	100V,Switching diode,MINI MELF	LL4148	ICM
6	1	L1	1mH,0.6A	C12-K7.5L GE-102	Mitsumi
7	1	R1	330K ,1%,1/4 W,Thick Film,1206	RC1206xR-073303L	Yageo
8	1	R2	30K ,1%,1/4 W,Thick Film,1206	RC1206xR-073002L	Yageo
9	1	RCS	0.68 ,1%,1/4 W,Thick Film,1206	RL1206xR-07R680L	Yageo
10	1	U1	Xlsemi ,XL8004 ,T0252-5L	XL8004	XLSEMI

Performance Data

Efficiency VS LED String

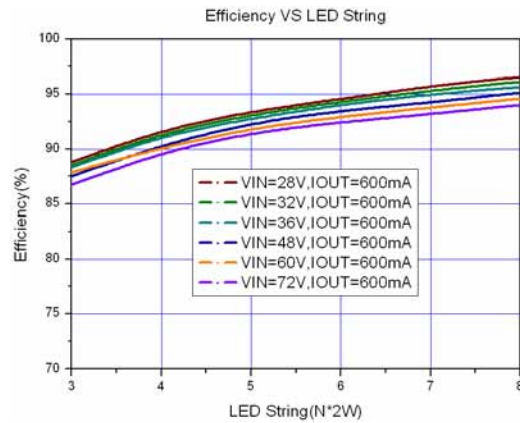
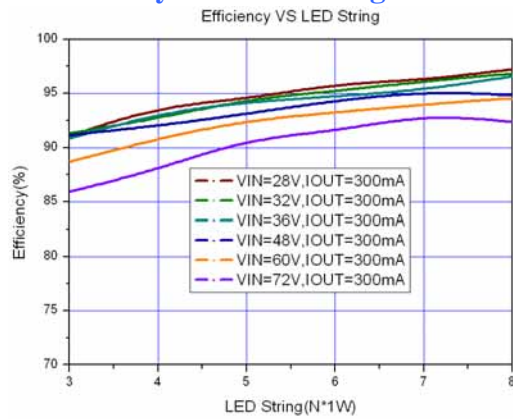

Line and Load Regulation

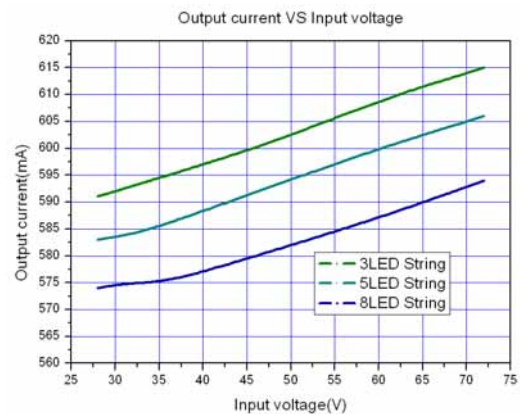
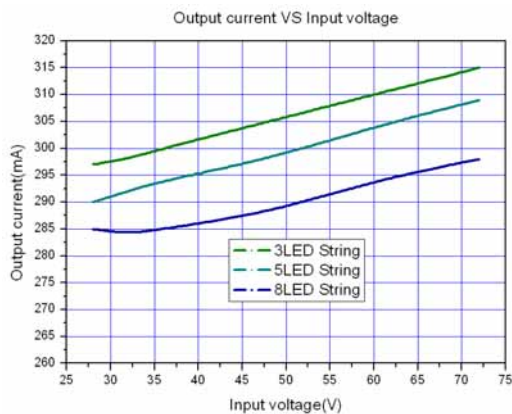

Populated Circuit Board Phtograph

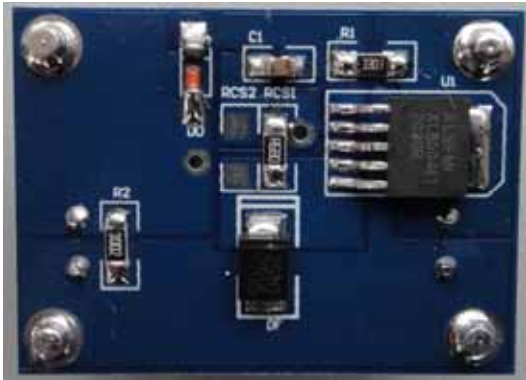

PCBLAYOUT

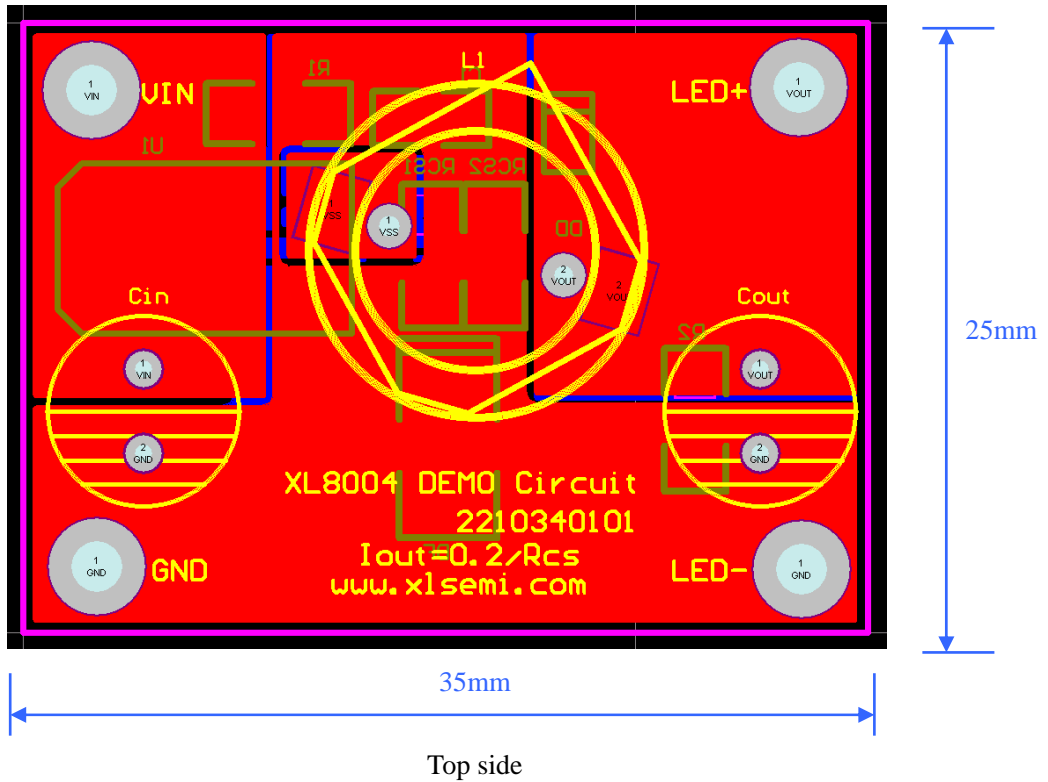

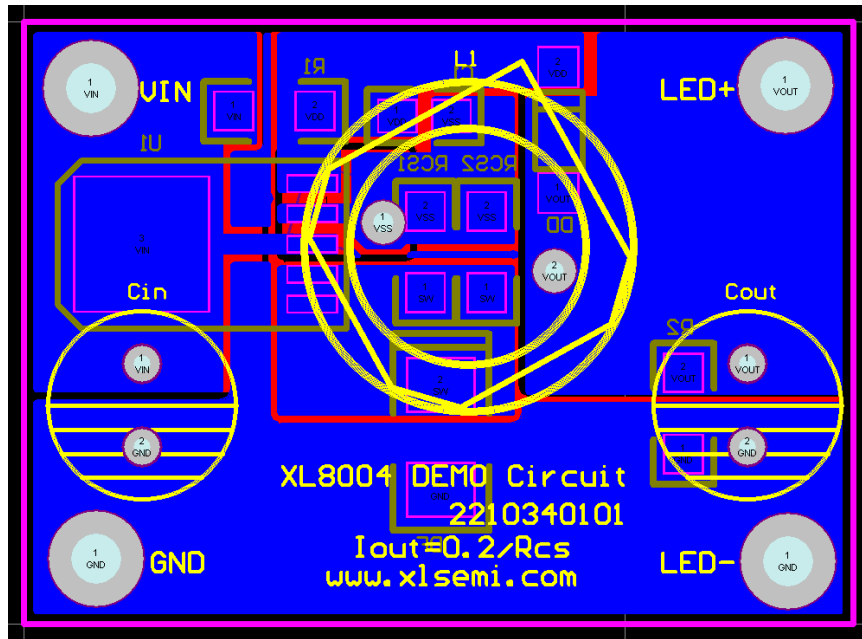

Bottom side

Typical application circuit for output Series8~14*1W LED

